

ALUMINUM
STOREFRONT

T700 Series

2" x 4-1/2" Thermally-Broken Center Set Storefront

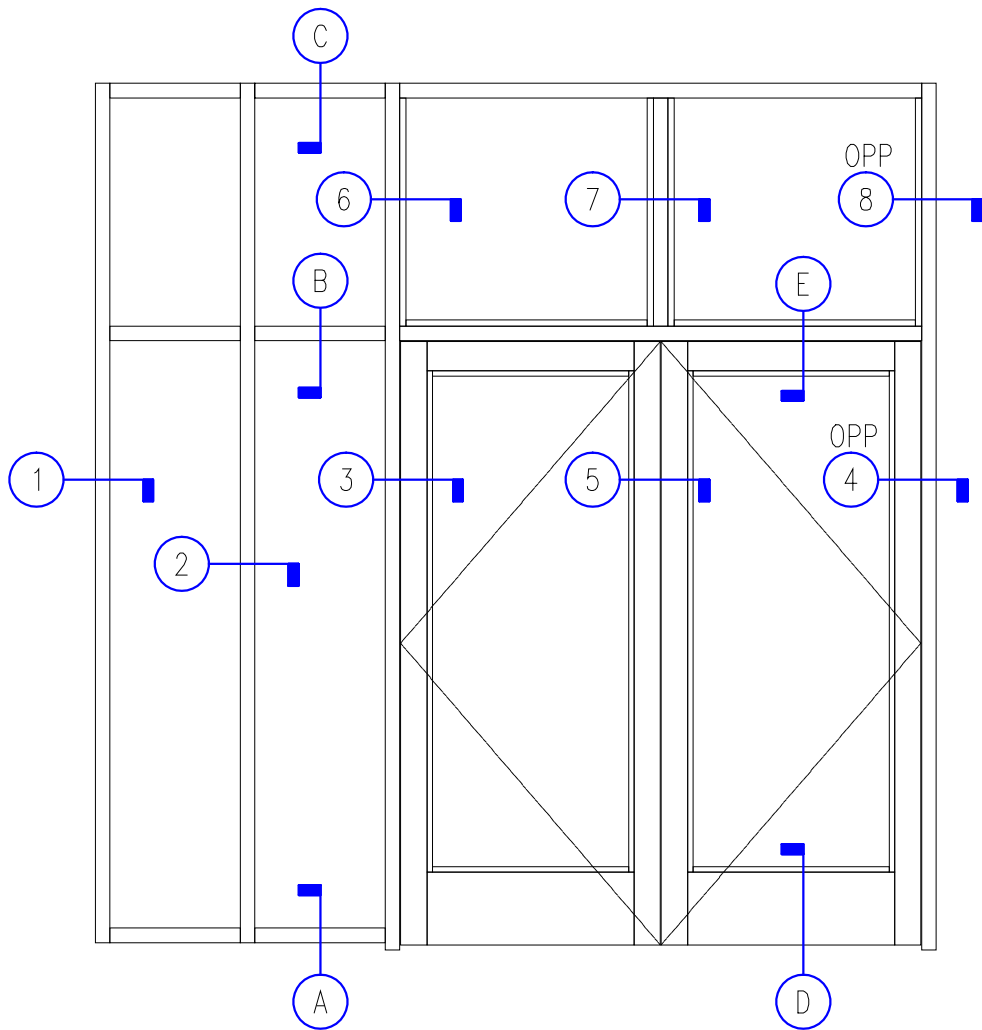

T700 with Door Incorporated

ALUMINUM
STOREFRONT

T700 Series

2" x 4-1/2" Thermally-Broken Center Set Storefront

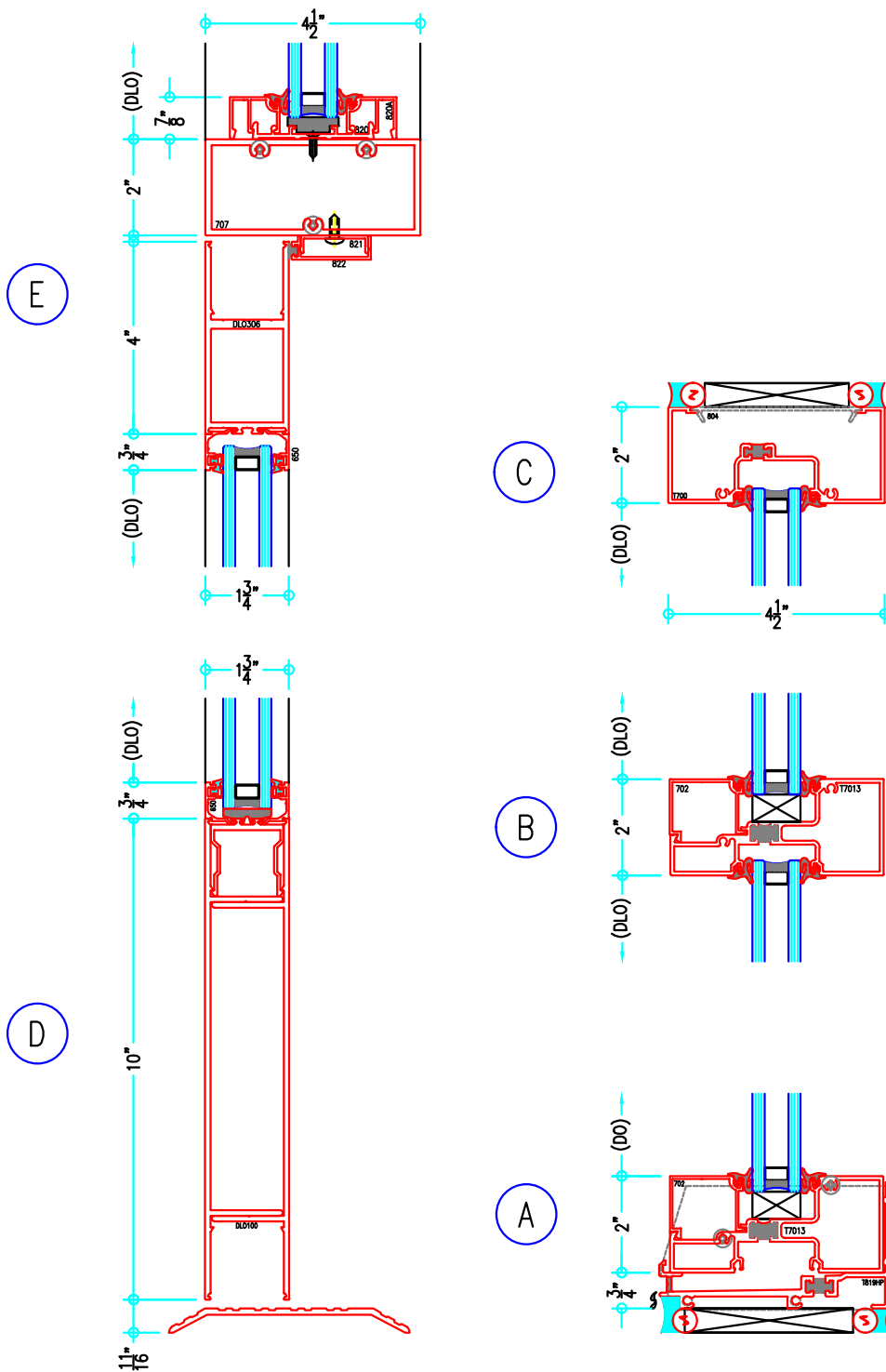

ALUMINUM
STOREFRONT

T700 Series

2" x 4-1/2" Thermally-Broken Center Set Storefront

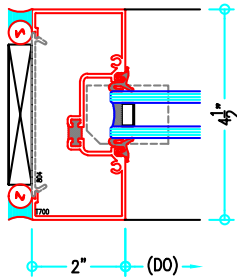

1

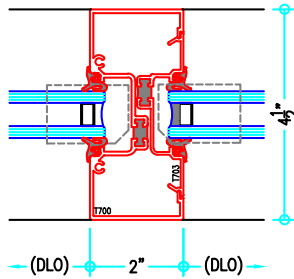

2

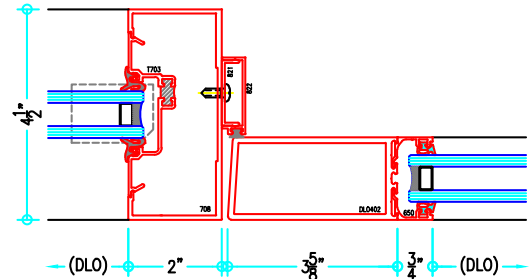

3

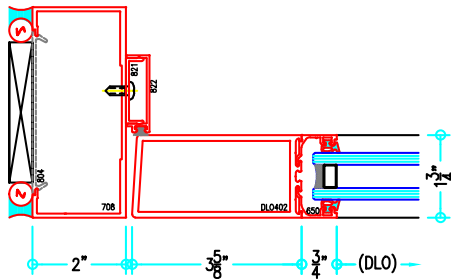

4

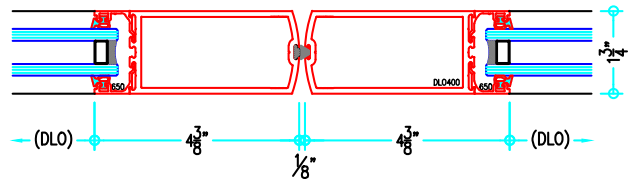

5

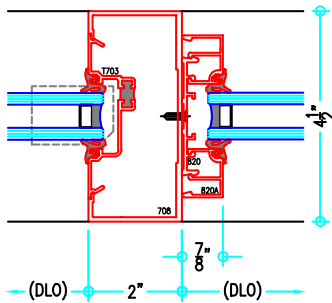

6

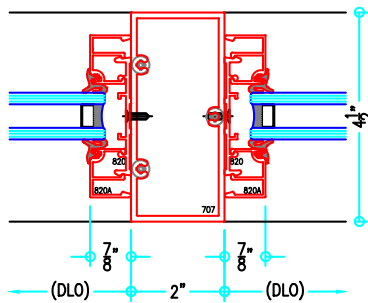

7

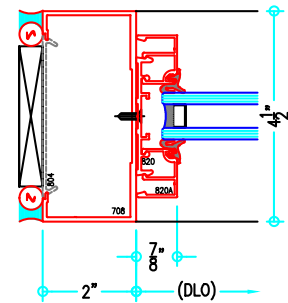

8

ALUMINUM
STOREFRONT

T700 Series

2" x 4-1/2" Thermally-Broken Center Set Storefront

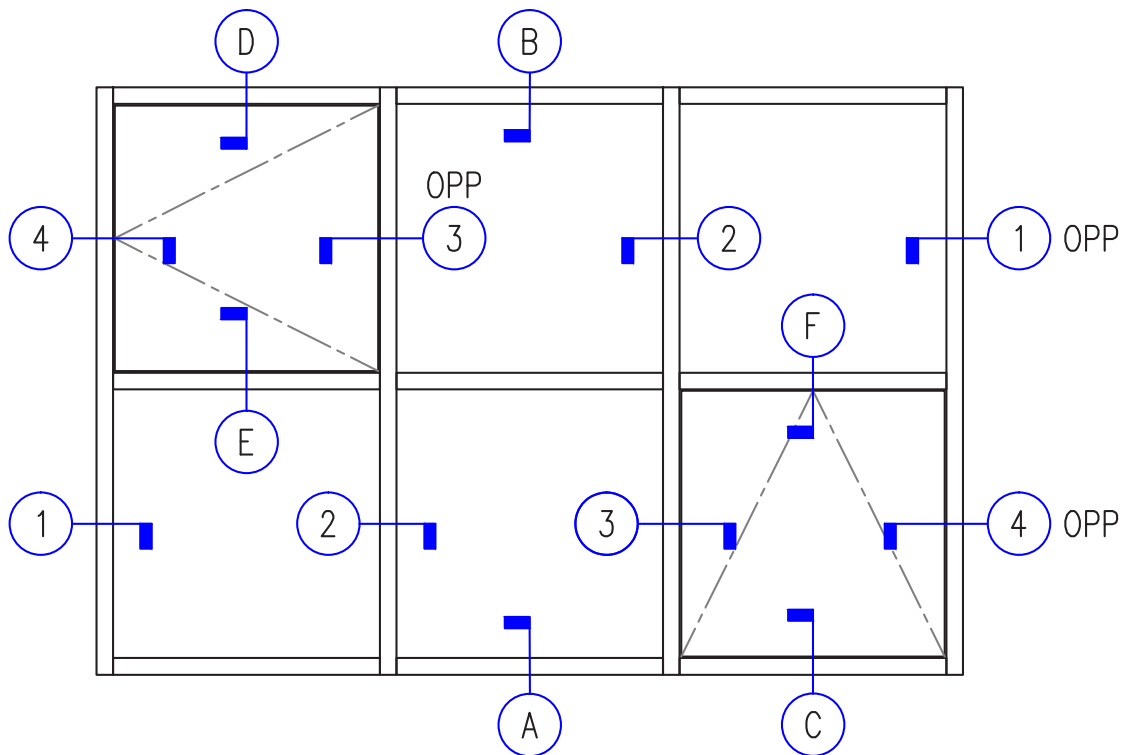

T700 with T550 Inviso Vent Insert

ALUMINUM
STOREFRONT

T700 Series

2" x 4-1/2" Thermally-Broken Center Set Storefront

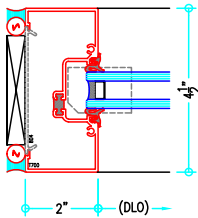

1

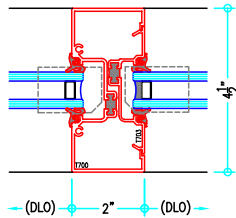

2

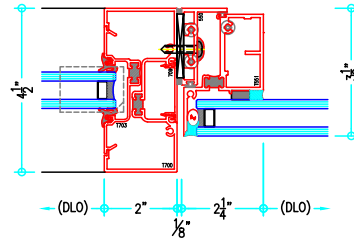

3

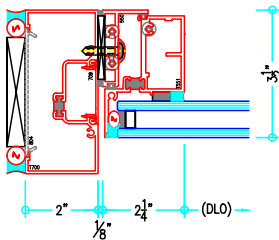

4

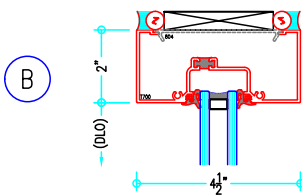

B

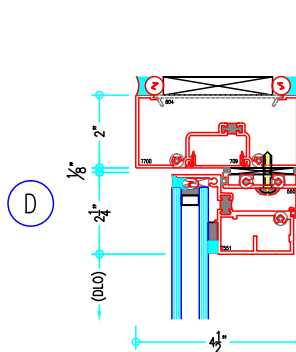

D

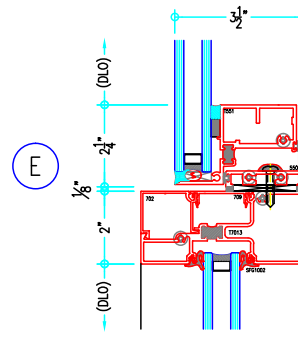

E

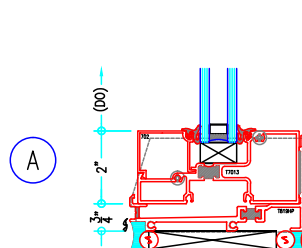

A

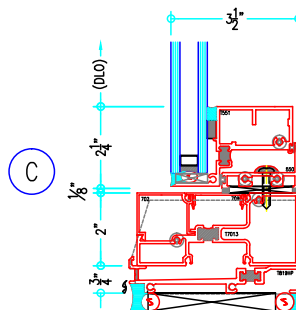

C

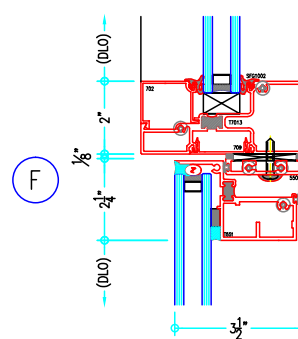

F

ALUMINUM
STOREFRONT

T700 Series

2" x 4-1/2" Thermally-Broken Center Set Storefront

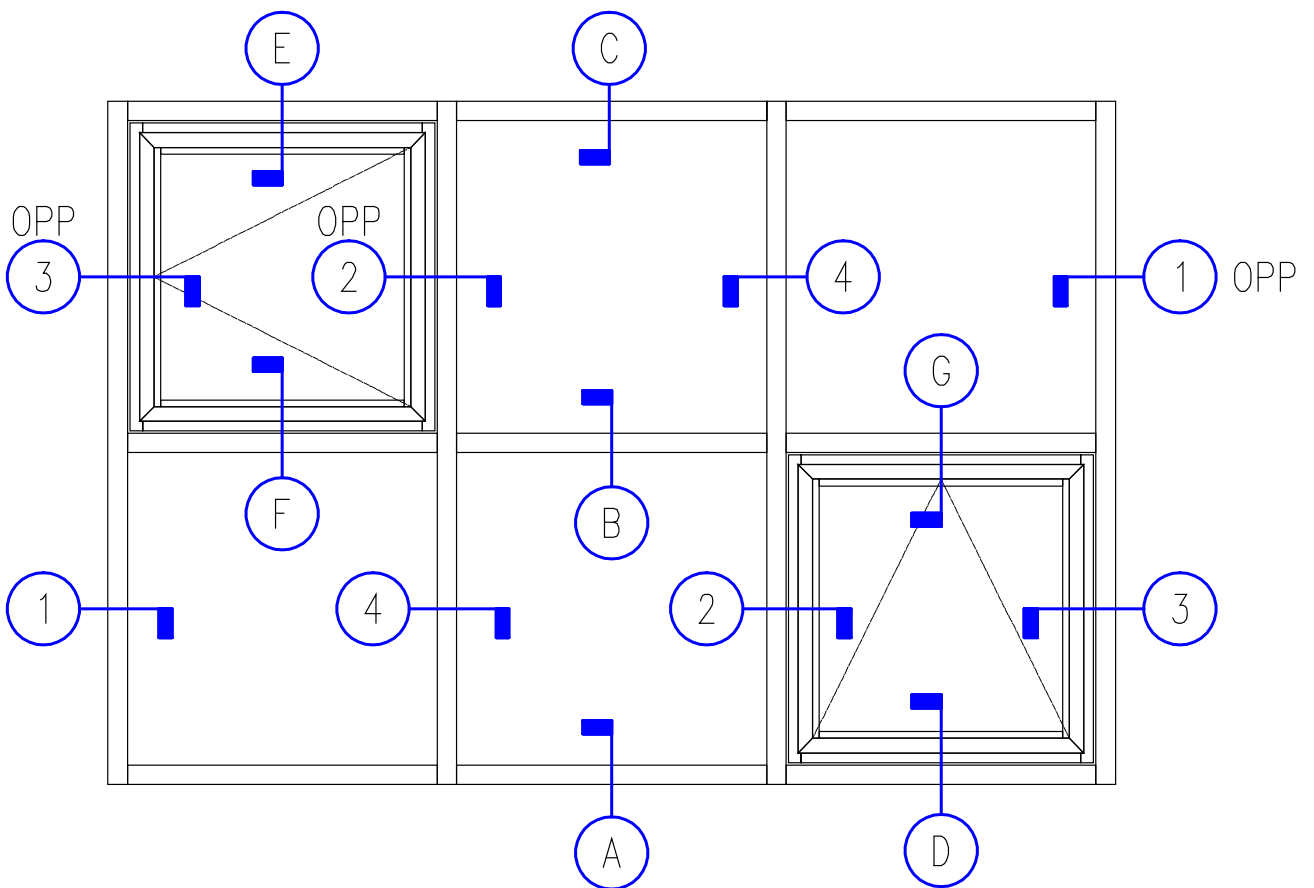

T700 with T4000 2"
Window Incorporated

ALUMINUM
STOREFRONT

T700 Series

2" x 4-1/2" Thermally-Broken Center Set Storefront

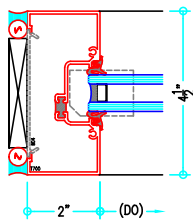

1

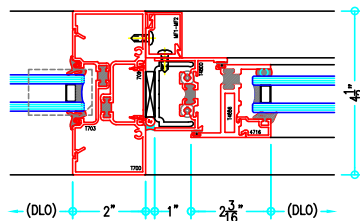

2

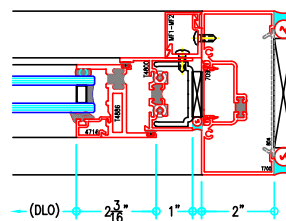

3

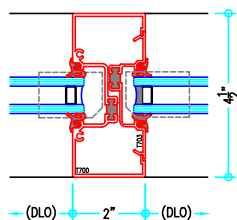

4

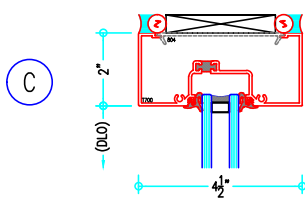

C

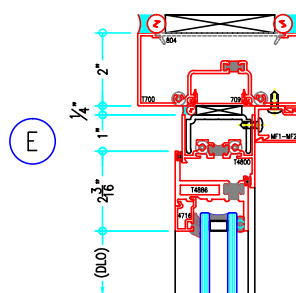

E

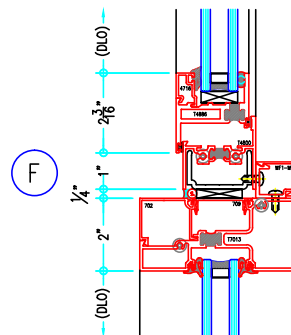

F

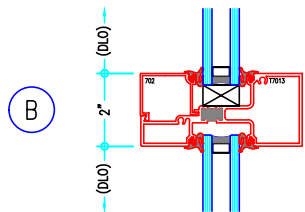

B

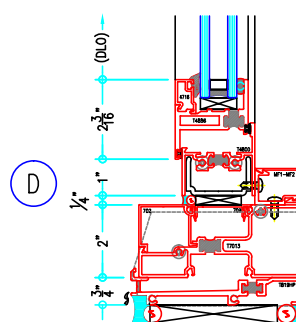

D

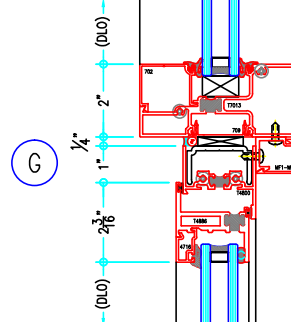

G

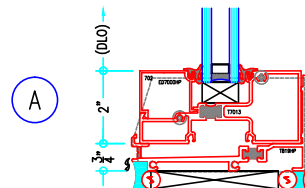

A

ALUMINUM
STOREFRONT

T700 Series

2" x 4-1/2" Thermally-Broken Center Set Storefront

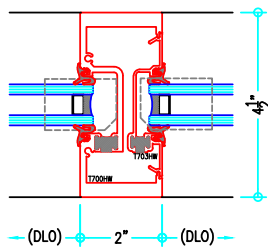

HEAVY WALL OPTION

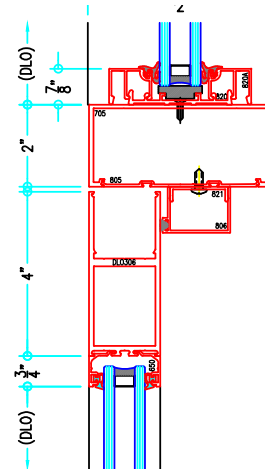

LARGE DOOR STOP
OPTION, HARDWARE
DEPENDANT

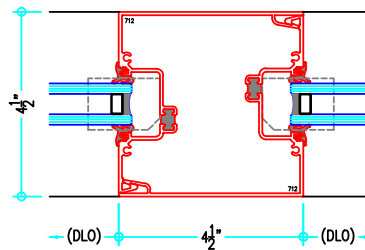
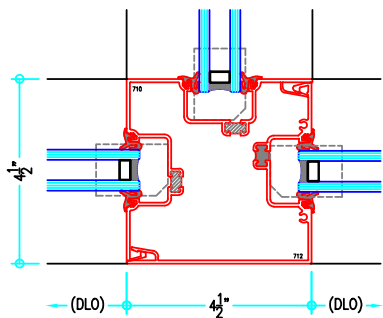
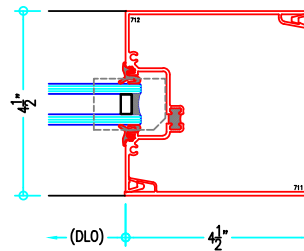
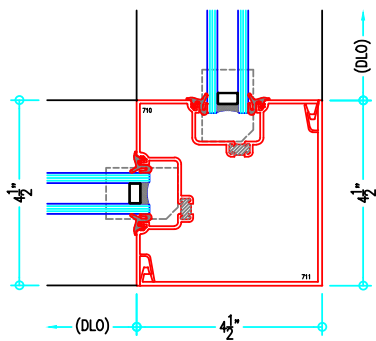

Options

T700 Series

2" x 4-1/2" Thermally-Broken Center Set Storefront

COMP CHANNEL
OPTION #1

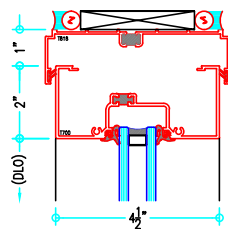

COMP CHANNEL
OPTION #2

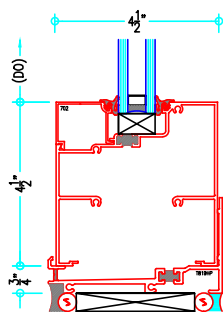
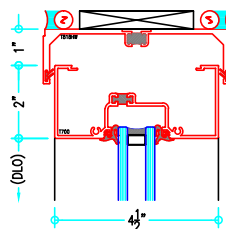

TALL SILL
OPTION #1



1/4" GLAZING
ADAPTER



THERMALLY BROKEN
SNAP PLATE